

Recon wall Engineers and Installers will need to take into account the horizontal wall layout to determine where to specify Half Blocks, Corner Blocks and Fitting Blocks. The location of these specialty blocks must be denoted on the vertical wall profile. With this information the Installer can coordinate delivery and staging of specialty blocks to ensure an uninterrupted installation.

**INSTANCES WHERE SPECIALTY BLOCKS MAY BE REQUIRED:**

**Outside 90° Corner**  
1 - Corner Block per Course

**A 1" Setback Wall, Outside (Convex) Radius (16'-32')**  
Fitting Blocks

**Tight Outside (Convex) Radius (8'-16')**  
Half Blocks, Fitting Blocks

**Tight Inside (Concave) Radius (8'-16')**  
Half Blocks, Fitting Blocks

**Fixed Point to Fixed Point**  
Half Blocks, Fitting Blocks

**Fixed Point to Outside Corner**  
Fitting Blocks, 1 - Corner Block per Course

**Outside Corner to Outside Corner**  
Fitting Blocks, 2 - Corner Blocks per Course

**Inside Corner (90° - 118°)**  
1 - Fitting Block per Course

**A 1" Setback Wall, Getting Back on Running Bond**  
Fitting Blocks

**Slip Joints**  
Half Blocks

**Outlet Pipe with 48 in Wide Concrete Collar**  
Half Blocks

**Drain Tile Outlets**  
Fitting Blocks (Hole Made Through 8.5" Face)

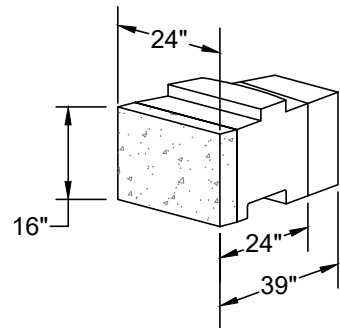

**HALF BLOCK**

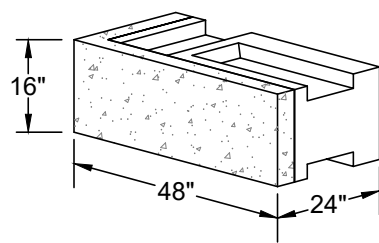

**REVERSIBLE CORNER BLOCK**

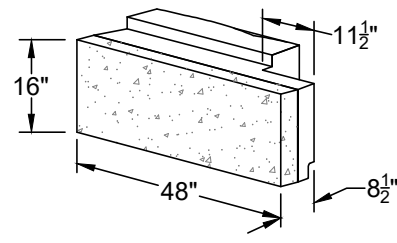

**STANDARD FITTING BLOCK**

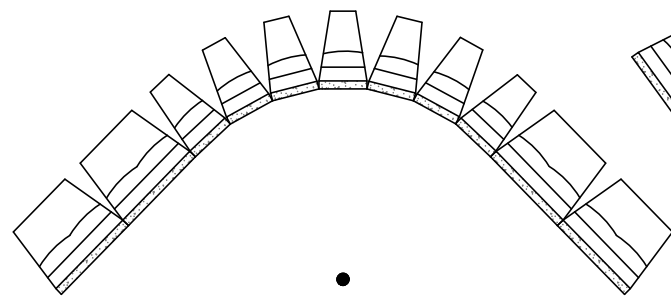

**TIGHT CONCAVE RADIUS**

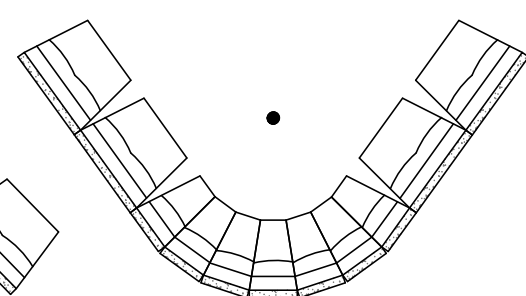

**TIGHT CONVEX RADIUS**

FULL TOP	HALF TOP	HALF TOP	HALF TOP	HALF TOP	HALF TOP	HALF TOP	HALF TOP	HALF TOP	FULL TOP
FULL	FITTING BLOCK	HALF	HALF	HALF	HALF	HALF	HALF	FITTING BLOCK	FULL
FULL	HALF	HALF	HALF	HALF	HALF	HALF	HALF	FULL	

**TIGHT RADIUS PROFILE VIEW**

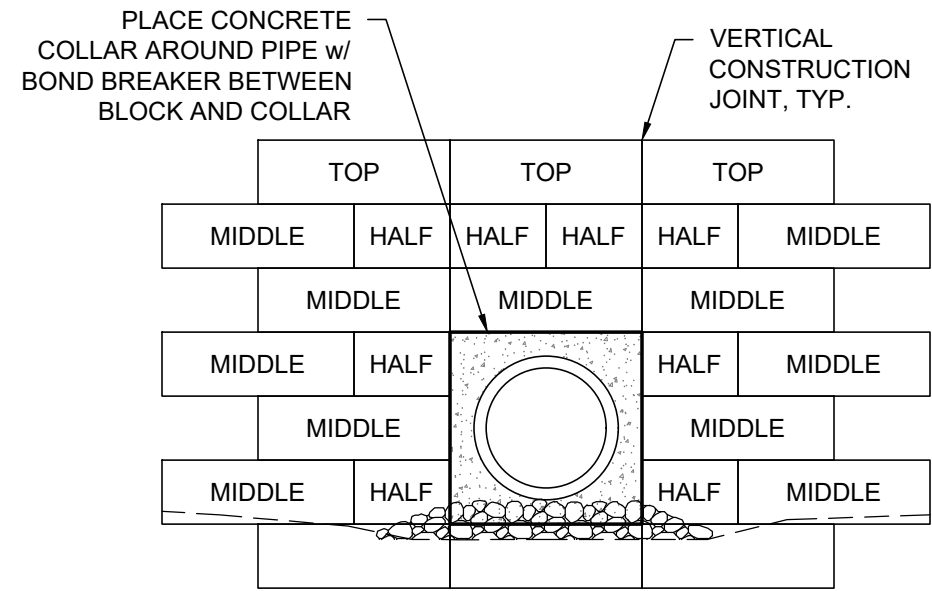

**OUTLET PIPE WITH 48" CONCRETE COLLAR**

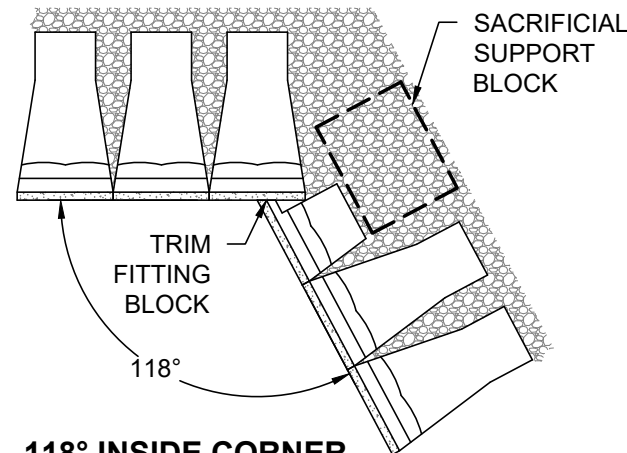

**118° INSIDE CORNER**

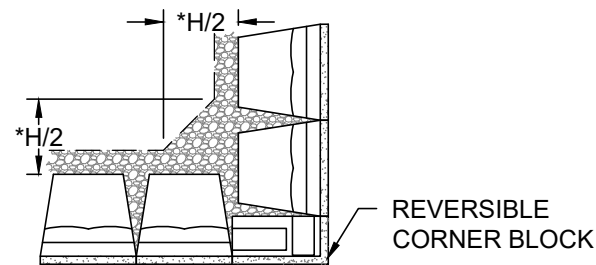

**OUTSIDE CORNER**

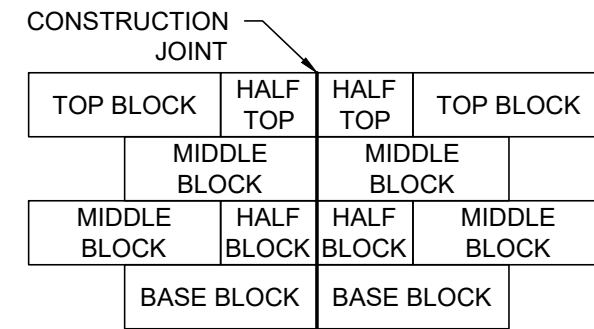

**SLIP JOINT**

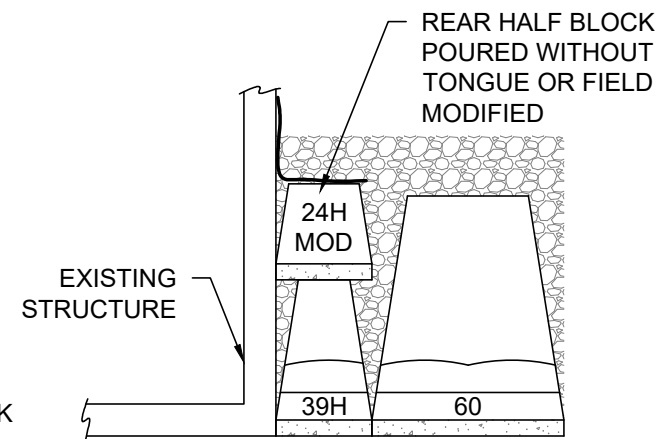

**AT FIXED POINT**

CORNER TOP - R	TOP BLOCK	TOP BLOCK	TOP BLOCK	TOP BLOCK	TOP BLOCK (42")	CORNER TOP - L
CORNER BLOCK	MIDDLE BLOCK	MIDDLE BLOCK	MIDDLE BLOCK	MIDDLE BLOCK	FITTING BLOCK (44")	CORNER BLOCK
CORNER BLOCK	MIDDLE BLOCK	MIDDLE BLOCK	MIDDLE BLOCK	MIDDLE BLOCK	FITTING BLOCK (46")	CORNER BLOCK
CORNER BLOCK	BASE BLOCK	BASE BLOCK	BASE BLOCK	BASE BLOCK	BASE BLOCK	CORNER BLOCK

**DOUBLE OUTSIDE 90° CORNER**

**RECON SPECIALTY BLOCKS**

**DRAWING #T52**

RECON WALL SYSTEMS, INC.  
11521 EAGLE STREET, SUITE #3  
COON RAPIDS, MN 55448  
952-922-0027  
www.reconwalls.com



Disclaimer: This drawing has been prepared by Recon Wall Systems, Inc. and to the best of its knowledge, accurately represents the product use in the application that it is illustrated. This drawing is intended for conceptual purposes only. Anyone making use of this drawing does so at their own risk and assumes all liability for such use. Final design for construction purposes must be completed by a Registered Professional Engineer who is familiar with the product and who has taken into account specific site conditions.